

Inductive sensor BI1.5-EG08-RP6X-V1131

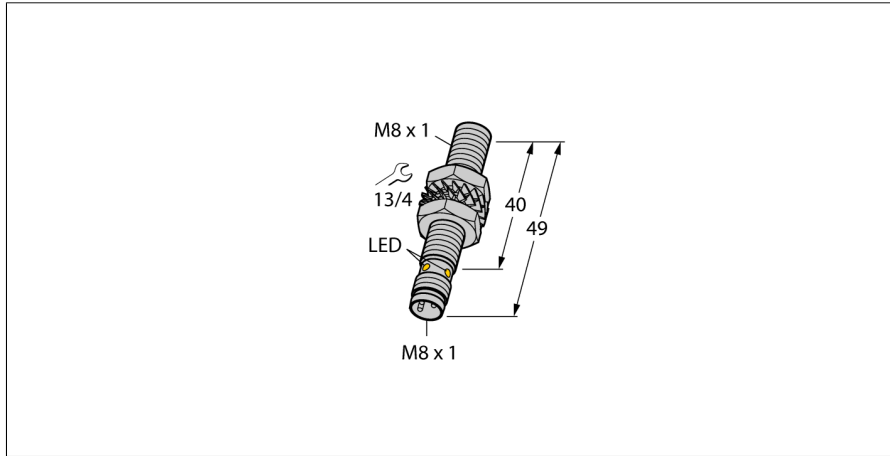

- Threaded barrel, M8 x 1
- Stainless steel, 1.4427 SO
- DC 3-wire, 10...30 VDC
- NC contact, PNP output
- M8 x 1 male connector

Wiring Diagram

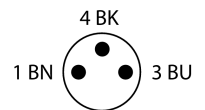
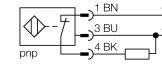

Type designation	BI1.5-EG08-RP6X-V1131
Ident-No.	4602203
Rated switching distance Sn	1.5 mm
Mounting conditions	Flush
Secured operating distance	≤ (0,81 x Sn) mm
Correction factors	St37 = 1; Al = 0.3; stainless steel = 0.7; Ms = 0.4
Repeat accuracy	≤ 2 % of full scale
Temperature drift	≤ ± 10 %
Hysteresis	3...15 %
Ambient temperature	-25...+70 °C
Operating voltage	10...30 VDC
Residual ripple	≤ 10 % U _{ss}
DC rated operational current	≤ 150 mA
No-load current I ₀	≤ 15 mA
Residual current	≤ 0.1 mA
Isolation test voltage	≤ 0.5 kV
Short-circuit protection	yes/ Cyclic
Voltage drop at I ₀	≤ 1.8 V
Wire breakage/Reverse polarity protection	yes/ Complete
Output function	3-wire, NC contact, PNP
Switching frequency	3 kHz
Design	Threaded barrel, M8 x 1
Dimensions	49 mm
Housing material	Stainless steel, 1.4427 SO
Active area material	Plastic, PA12-GF30
Max. tightening torque housing nut	5 Nm
Electrical connection	Connector, M8 x 1
Vibration resistance	55 Hz (1 mm)
Shock resistance	30 g (11 ms)
Protection class	IP67
MTTF	2283 years acc. to SN 29500 (Ed. 99) 40 °C
Switching state	LED, Yellow

Functional principle

Inductive sensors detect metal objects contactless and wear-free. For this, they use a high-frequency electromagnetic AC field that interacts with the target. Inductive sensors generate this field via an RLC circuit with a ferrite coil.

**Inductive sensor
BI1.5-EG08-RP6X-V1131**

Accessories

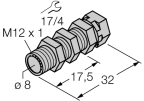
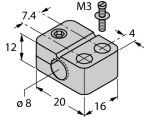
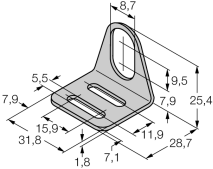
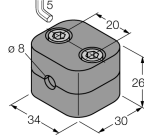
Type code	Ident-No.	Description	
QM-08	6945100	Quick-mount bracket with dead-stop, chrome-plated brass, male thread M12 x 1. Note: The switching distance of proximity switches may be reduced through the use of quick-mount brackets.	
BST-08B	6947210	Fixing clamp for threaded barrel devices, with dead-stop; material: PA6	
MW-08	6945008	Mounting bracket for threaded barrel devices; material: Stainless steel A2 1.4301 (AISI 304)	
BSS-08	6901322	Mounting bracket for smooth and threaded barrel devices; material: Polypropylene	
MBS80	69479	Mounting bracket for threaded barrel devices; material mounting block: Anodized aluminium	